

## DH-CA-F681E

700TVL Day/Night HLS Camera



### Features

- 1/3" SONY EXview HAD CCD II & Effio-S DSP
- High resolution of 700TVL
- HLS, DWDR, Day/Night(ICR), 3DNR, Auto iris, AWB, AGC, BLC, MD, DZOOM, DIS, Privacy Masking, Picture Adjustment
- OSD, AC24V/DC12V

# DH-CA-F681E

## Technical Specifications





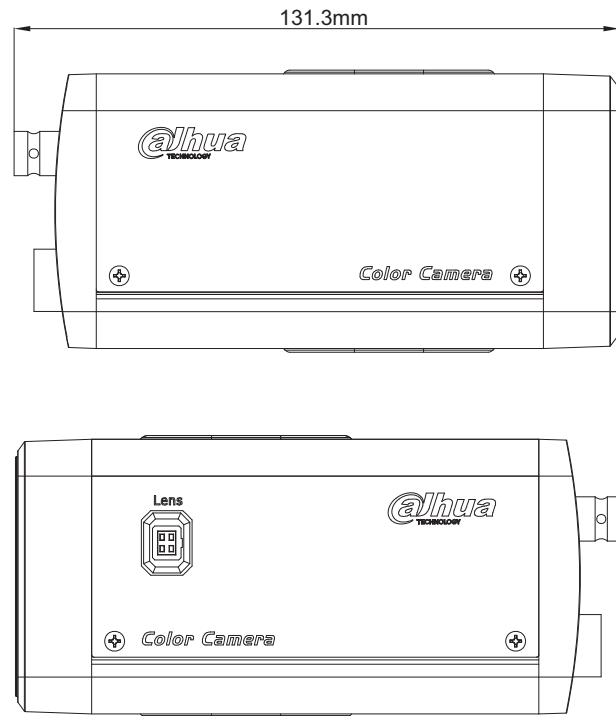
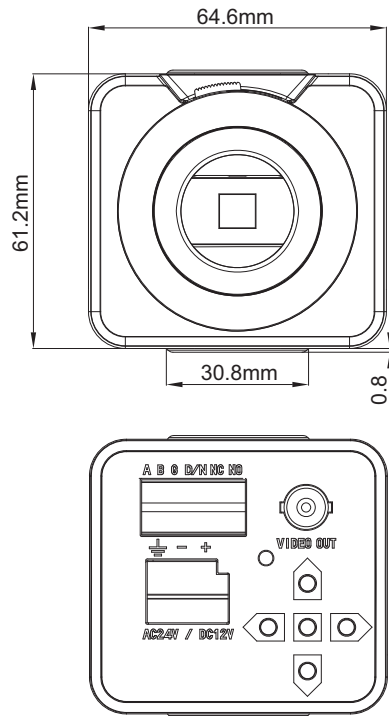

Model	DH-CA-F681EP-A	DH-CA-F681EN-A
<b>Camera</b>		
Image Sensor	1/3" SONY EXview HAD CCD II	
Effective Pixels	976(H)×582(V), 570K pixels	976(H)×494(V), 480K pixels
Horizontal Resolution	700TVL	
Electronic Shutter	1/50s~1/100,000s, 10s~1/100,000s@Slow shutter, 512x	1/60s~1/100,000, 8s~1/100,000s@Slow shutter, 512x
Synchronization	Internal	
Min. Illumination	Color: 0.001Lux@F1.2, 0.0001Lux@F1.2(Slow shutter, 512x)	
	B/W: 0.0001Lux@F1.2, 0.00001Lux@F1.2(Slow shutter, 512x)	
S/N Ratio	>65dB	
Video Output	1Vp-p Composite Output (75Ω/BNC)	
<b>Camera Features</b>		
OSD	English, Chinese	
Day/Night	Auto (ICR) / B/W / Color	
Backlight Compensation	HLS / BLC / HLC / DWDR	
White Balance	Auto Trace WB1 / Auto Trace WB2 / Manual / Auto	
Gain Control	Auto / Manual	
Noise Reduction	2D / 3D	
Privacy Masking	Up to 4 areas	
Digital Zoom	Magnitude / Horizontal / Vertical	
Picture Adjustment	Mirror / Brightness / Contrast / Sharpness / Hue / Gain / Slow Shutter	
<b>Lens</b>		
Lens Type	Manual / Auto iris	
Mount Type	C/CS	
<b>Auxiliary Interface</b>		
RS485	1 Port	
<b>General</b>		
Power Supply	AC24V±10% / DC12V±10%	
Power Consumption	Max 6W	
Working Environment	-30°C~+60°C / 20%~80%RH	
Dimensions (W×D×H)	64.6mm×131.3mm×61.2mm	
Weight	0.5kg	

# DH-CA-F681E

## Dimensions (mm)



## Accessories (optional)

				
PFB120W	PFB121W	PFA121	PFA150	PFA152
				
PFH600N	PFH610N			

Dahua Technology Co., Ltd. 1187BinAn Road, Binjiang District, Hangzhou, China

Tel: 66956096-09126017817-09107616575

email:imensazaa@gmail.com

www.irandahua.com